

Data Sheet



Article number: 586LX3

Description: Silencers LX-03, - G 3/8"
Silencer With Hi-Flow

Measures

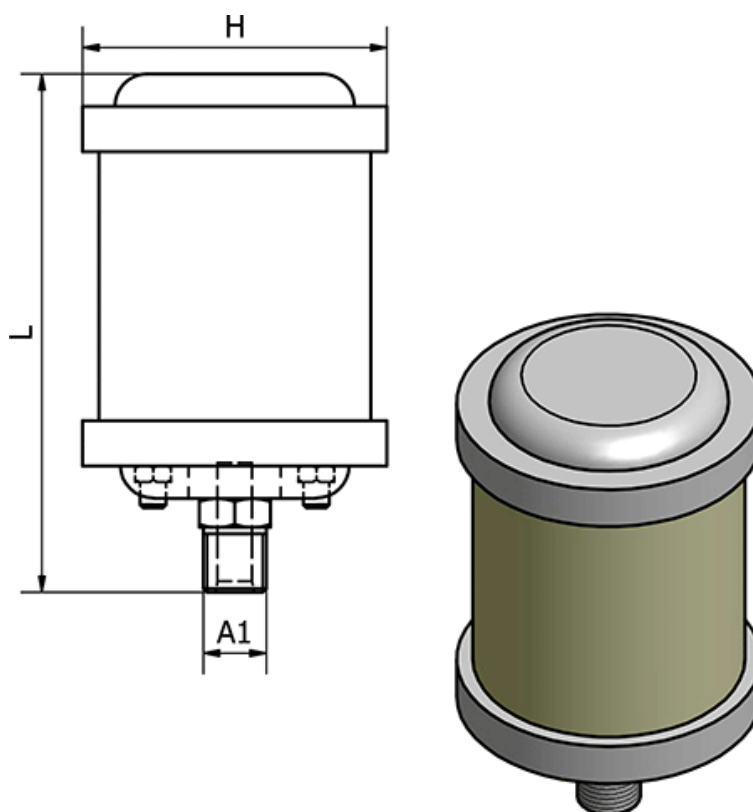

Flow l/min at 5 bar = 4500

H = 66

L = 130

Thread A1 = G 3/8"